

SALTO
inspiredaccess

Contactless solutions | networked locking system



**ONE CARD,
ONE TECHNOLOGY
UNLIMITED POSSIBILITIES**

ONE CARD, ONE TECHNOLOGY UNLIMITED POSSIBILITIES

Introducing the new **XS4 RFID** system, a new concept in access control that allows you to **JUMP** up to the next level when your needs change.

SALTO Systems unique new networked lock set can be used for a huge range of access control applications. It s the first RFID system that can be upgraded at any time.

You choose the level of control you need. From a simple self programmable system that needs no computer to manage it, through a highly capable mid-range ROM system up to the high performance data on card technology SALTO Virtual Network (SVN) system that allows you to control all the doors in an entire building or group of buildings from a single PC. And now with the brand new XS4 on-line battery operated wireless lock system you can experience real time access control solutions without the need for wiring.

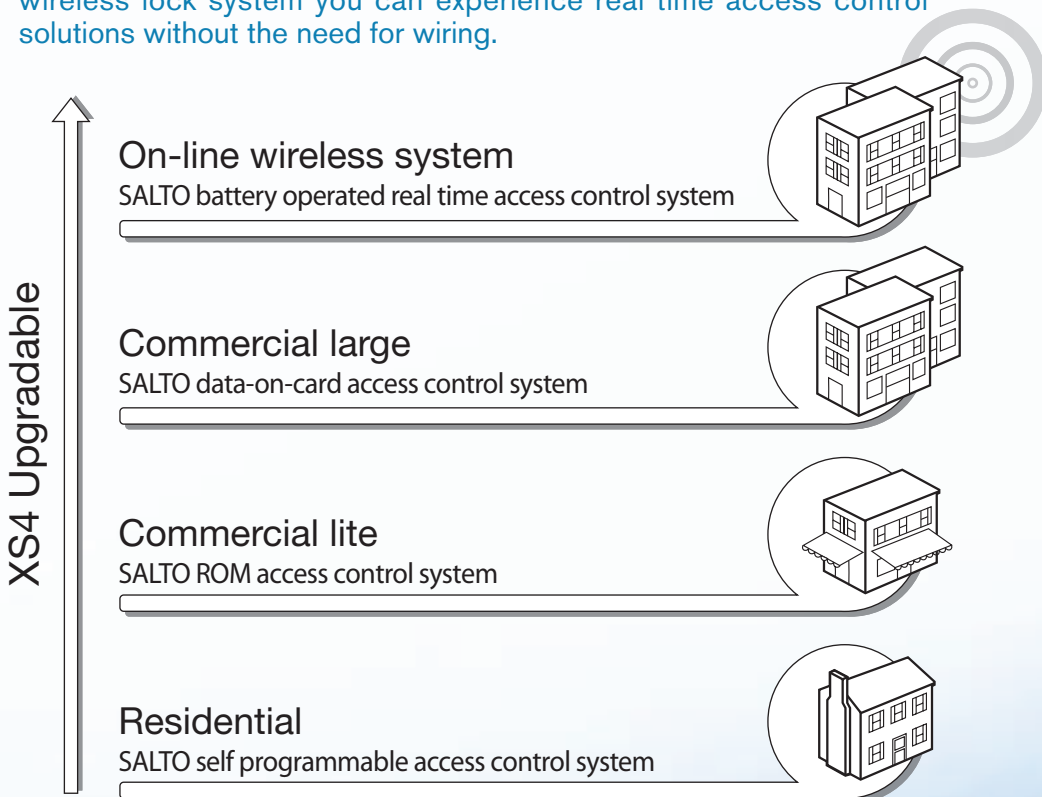

Grand Hotel in Lytham St Annes · UK Passport Offices · Edinburgh
Sydney University Village · Australia · St Francis · Ass







RESIDENTIAL APPLICATIONS

a new era in your life - keyless world

Unlike conventional locks where if the keys are lost you have the expense and inconvenience of replacing all the affected locks and keys with the new SALTO XS4 RFID e-lock or e-cylinder self programmable system you just delete the missing key from the system and issue a new one to the user. It s that simple.

How does it work?

If you need to add new users you just have to present the programming key once to the reader followed by the user keys that you want to operate this lock. You can close the programming procedure by presenting the programming key again at the end, or wait 5 seconds for the lock to close the programming mode itself (a single beep will be heard).

If you want to delete a user key, which is still in your possession, you simply present the programming key followed by the user key (or keys) you want to delete. The process is closed by presenting the programming key again, or by time out.

If a user key is lost it can be deleted from a lock just by touching the shadow card of this user key to the reader. The user key related to the shadow key used is then deleted.

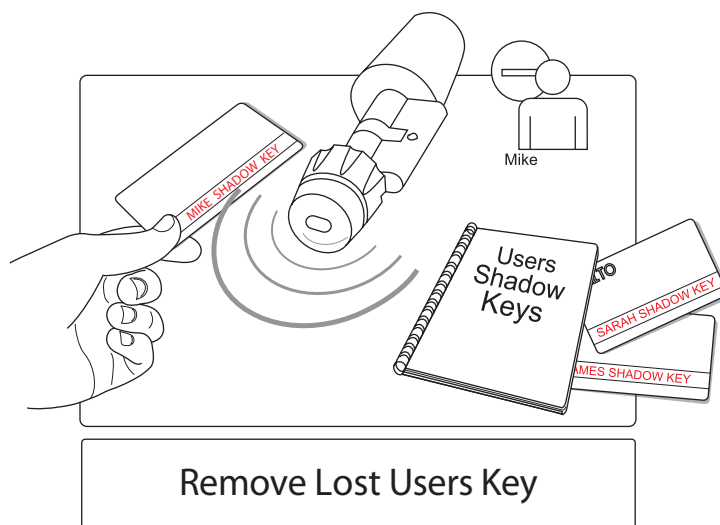
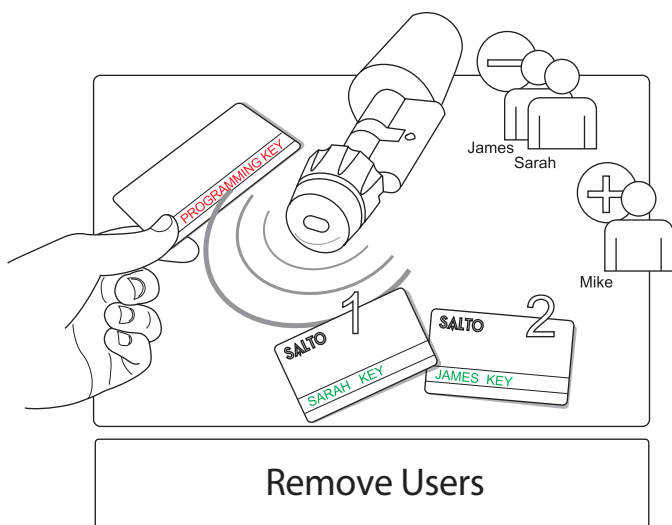
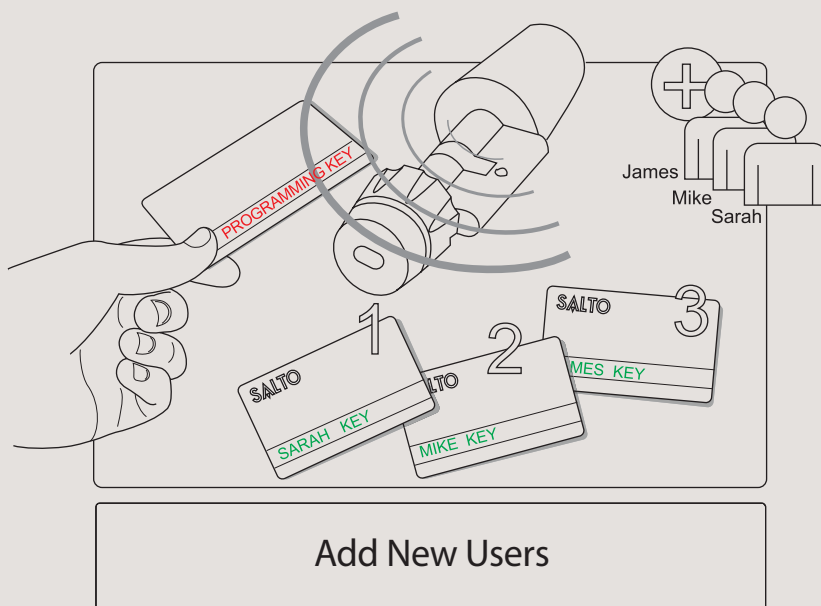

Main features and advantages

- **Wire free and battery powered**, no complicated installation is needed and the existing mortise lock can be kept reducing the installation cost.
- **The electronic cylinder is approved** to the highest European security standards including VdS in Germany and SKG in the Netherlands.
- **Needs no computer**, all key maintenance is done through a programming key and user s shadow keys. This allows up to 1000 system users.
- **Available in a huge range of solutions depending on the door** as e-lock or electronic cylinder, wall readers, automatic door version, panic bar and euro mortise lock.
- **Available passage mode** in all versions, permitting the door to be opened if needed.
- **Emergency opening can be performed** if needed through the EPS100.
- **The system can be upgraded** simply by using a Portable Programming Device (PPD) making it possible to upgrade to a ROM system or a data on card SVN system when your needs change.



COMMERCIAL LITE

If you need a higher level of control over who is entering your building and when, the SALTO XS4 RFID ROM is the answer. It is designed for use in small to medium sized businesses, retail premises and office buildings that only need to control a small number of doors and users. It provides all the benefits of a stand alone access control system in a compact, cost effective package.

No complicated wiring or other intrusive work is required and you can continue to use your existing mortise locks – reducing the installation cost. It's easy to use Pro Access ROM software can be customized to suit your needs so you can add users and doors, user groups and zones and set time periods and opening modes that instruct the door to lock or unlock automatically as needed.

And if your access control needs grow, the XS4 RFID ROM system can be upgraded at any time to a complete data on card SVN system without having to change any of the door hardware.

How does it work?

The SALTO XS4 RFID ROM system can use all current RFID cards (in self programming mode) enabling you to enrol users without any need to write on the card. This makes it possible to work with all the popular types of transport cards including bus and train cards with no programming and no approvals required.

It's also very simple to use. Any changes you make such as adding new users, deleting users, updating the e-lock, e-cylinder or wall reader, or collecting the event audit trail are done through its Pro Access ROM software.

When complete, these changes are downloaded into a Portable Programming Device (PPD) in order to then update all the off-line e-locks, or e-cylinders. Each time you connect the PPD to an e-lock, e-cylinder or wall reader, the software will automatically download the battery status and the event audit trail so that this information can be updated on the computer. This allows users to program for or plan maintenance when convenient and, if required, also provides management reports on user access movements around the building.

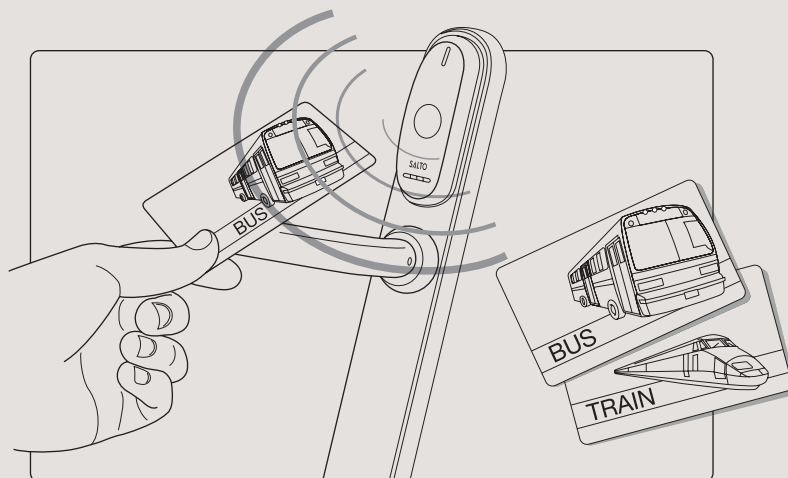

You can use existing **RFID** cards
No card issuing required

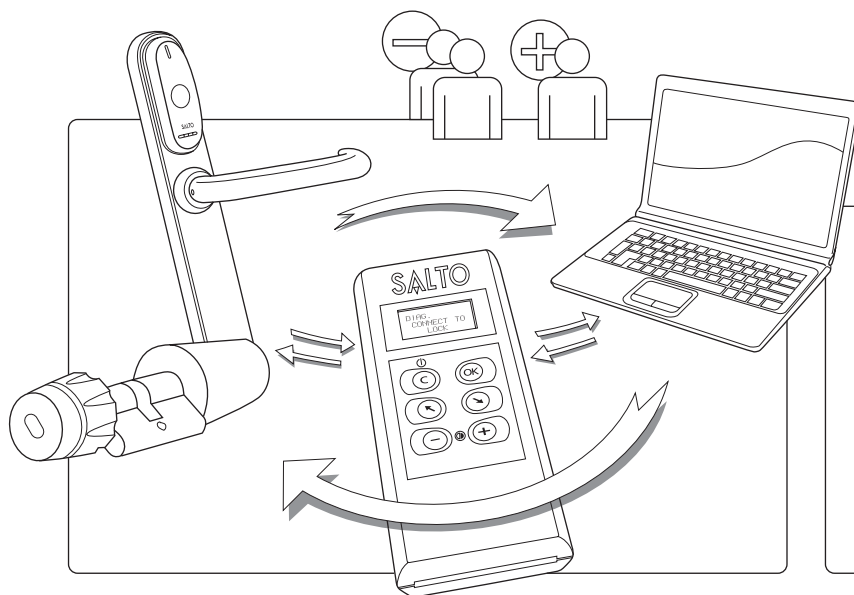

- Add or delete user
- Set up users profiles (calendars, shifts...)
- Change lock opening modes
- Event audit trail
- Stand alone locks battery status remote report

Main features and advantages

- **Wire free and battery powered**, no complicated installation is needed and the existing mortise lock can be kept reducing the installation cost for almost every kind of door.
- **Computer managed** permitting the configuration of the e-locks, monitoring of access flows, record access, add and remove users and set up the user access profile.
- **The system can manage** up to 16000 users and 64000 doors.
- **8 different opening modes** to suit your needs (standard, free passage ability, free passage with automatic locking, Automatic opening, Toggle, and timed Toggle).
- **256 time zones** and 256 calendars.
- **1000 door events** held in the lock / e-cylinder memory.
- **The system can be upgraded** simply by using a Portable Programming Device (PPD) making it possible to upgrade to a data on card SVN system when your needs change.
- Multiplication through the **RFID** carrier enables use of existing MIFARE/DESFIRE, HID iCLASS or PICOPASS cards.



COMMERCIAL LARGE - Data on card locking system

The SALTO XS4 data on card access control system is designed for use in larger buildings such as universities, airports, hospitals etc. It enables users to work in a wire free environment so there is no need to hard wire. This allows you to keep your original doors and locks in place, making installation fast, self contained and straight forward.

It allows you to control your entire building remotely and in almost real time through the SALTO Virtual Network (SVN). This advanced software system allows stand alone locks to read, receive and write information via its operating smart cards or intelligent keys. This data is captured from the cards at SVN on-line hot spots located at strategic points around the building. The hot spot uploads and downloads user related information that is then used to permit, control or deny access.

How does it work?

The **SALTO XS4 RFID data on card system** uses SALTO Virtual Network (SVN) technology to convert a stand alone access control system into a networked system. Simply by using the RFID card on the network you distribute all the latest access information to the off-line stand alone locks, including the data on deleted cards, while at the same time it picks up lock/cylinder data like opening events and battery status.

SVN does this for every employee in the building. So whether you need to control 6 doors or 64,000 doors and no matter how many people need to access the building, SVN ensures all the hot spots and locks are kept updated and secure. This provides the security or building manager with what they need most – total control.

To learn more about the SALTO Virtual Network visit:
www.dataoncard.net

Access to on-line point - the entrance door

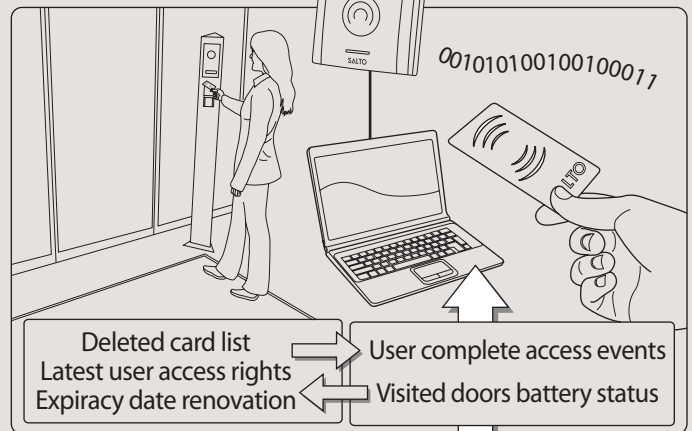

- Add or delete users remotely
- Update users profile "on the fly" (Calendars, shifts...)
- Dynamic event audit trail
- Remote stand alone device battery status report
- Expiry date renovation

Access to off-line point - Sarahs office room

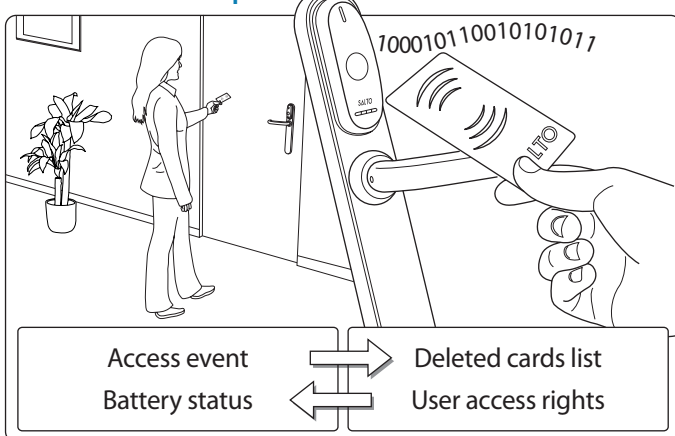

Access to on-line point - the exit doors

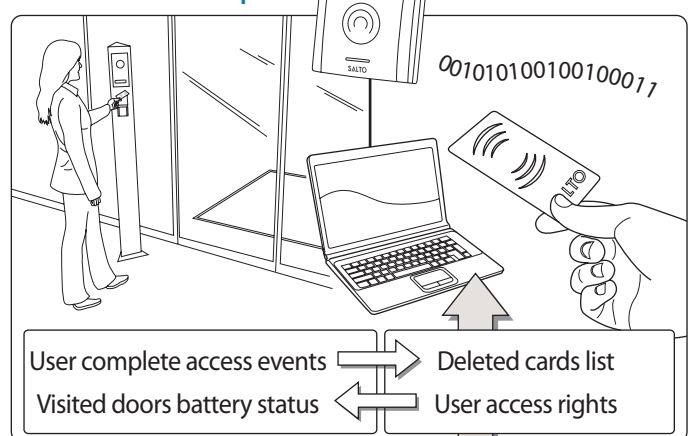

- Add or delete users remotely
- Update users profile "on the fly" (Calendars, shifts...)
- Dynamic event audit trail
- Remote stand alone device battery status report

Main features and advantages

- **Wire free and battery powered**, no complicated installation is required and the existing mortise lock can be retained reducing the installation cost.
- **SALTO Virtual Network** capabilities in all the locks.
- **Computer managed** on-line and off-line doors with SQL data base and a huge number of functions and capabilities.
- **Up to 64000 users** and 64000 doors in one unique system.
- **256 time zones** and 256 calendars.
- **1000 door events** held in the lock / e-cylinder memory.
- **Emergency openings can be performed** through the PPD.
- Multiplication through the **RFID carrier** enables use of existing MIFARE/DESFIRE, HID iCLASS or PICOPASS cards.

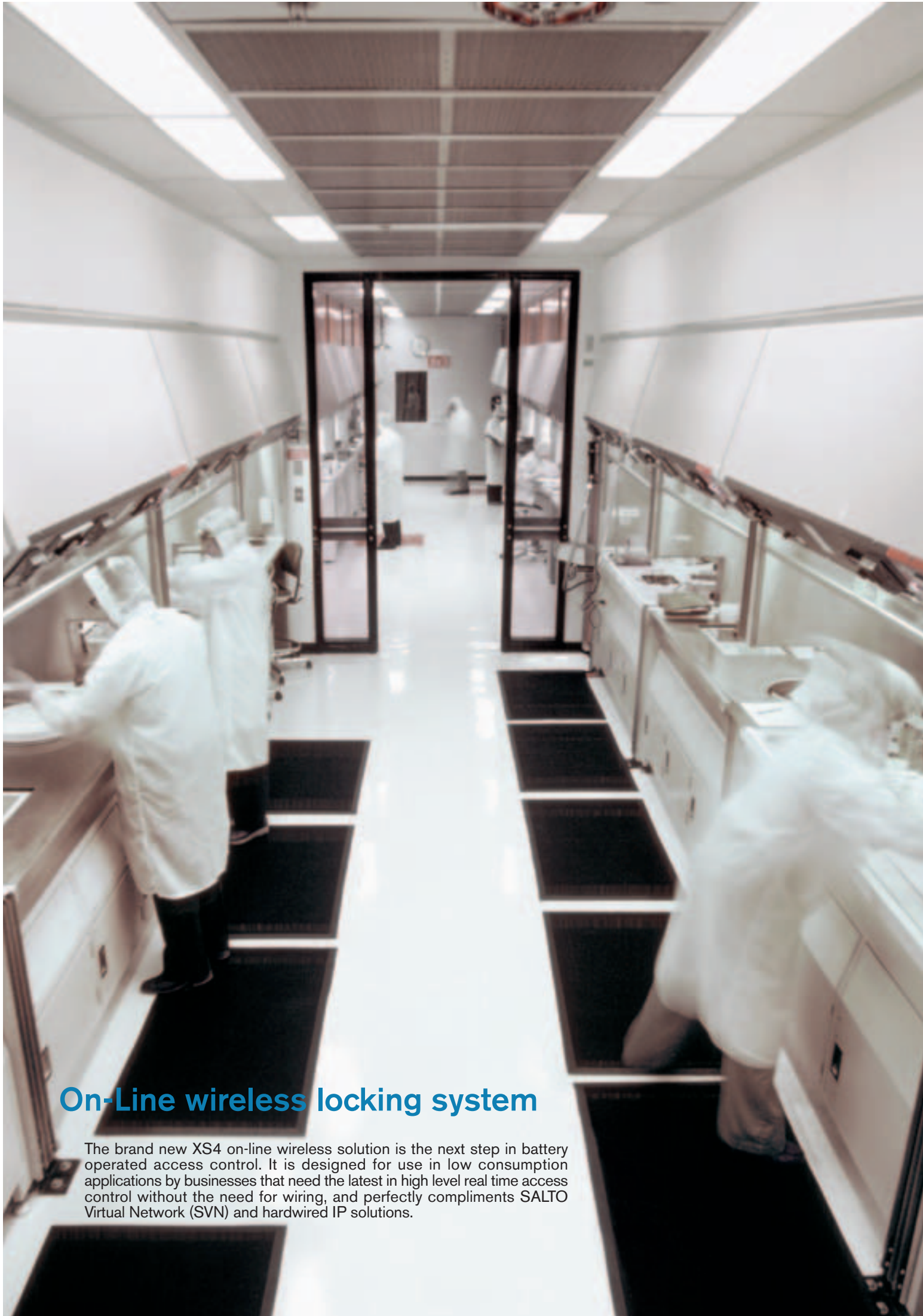

On-Line wireless locking system

The brand new XS4 on-line wireless solution is the next step in battery operated access control. It is designed for use in low consumption applications by businesses that need the latest in high level real time access control without the need for wiring, and perfectly compliments SALTO Virtual Network (SVN) and hardwired IP solutions.

How does it work?

XS4 RF is a new generation on line access control system that is on-line but also off-line. It connects battery powered electronic escutcheons by means of low power radio transceivers (2.4 GHz) fitted on the inside of the escutcheons. These interact with XS4 gateways (which are connected by Ethernet/WIFI to the central management computer) and XS4 repeaters fitted in pre-defined XS4 RF areas to provide a real time wireless access control network.

It can also carry out many of the functions that were previously done using a Portable Programming Device (PPD) or SALTO Virtual Network (SVN) and in the unlikely event that the radio link is interrupted, the escutcheons will continue to work but off-line, as with a standard SALTO escutcheon and all standard SVN functions will remain operative.

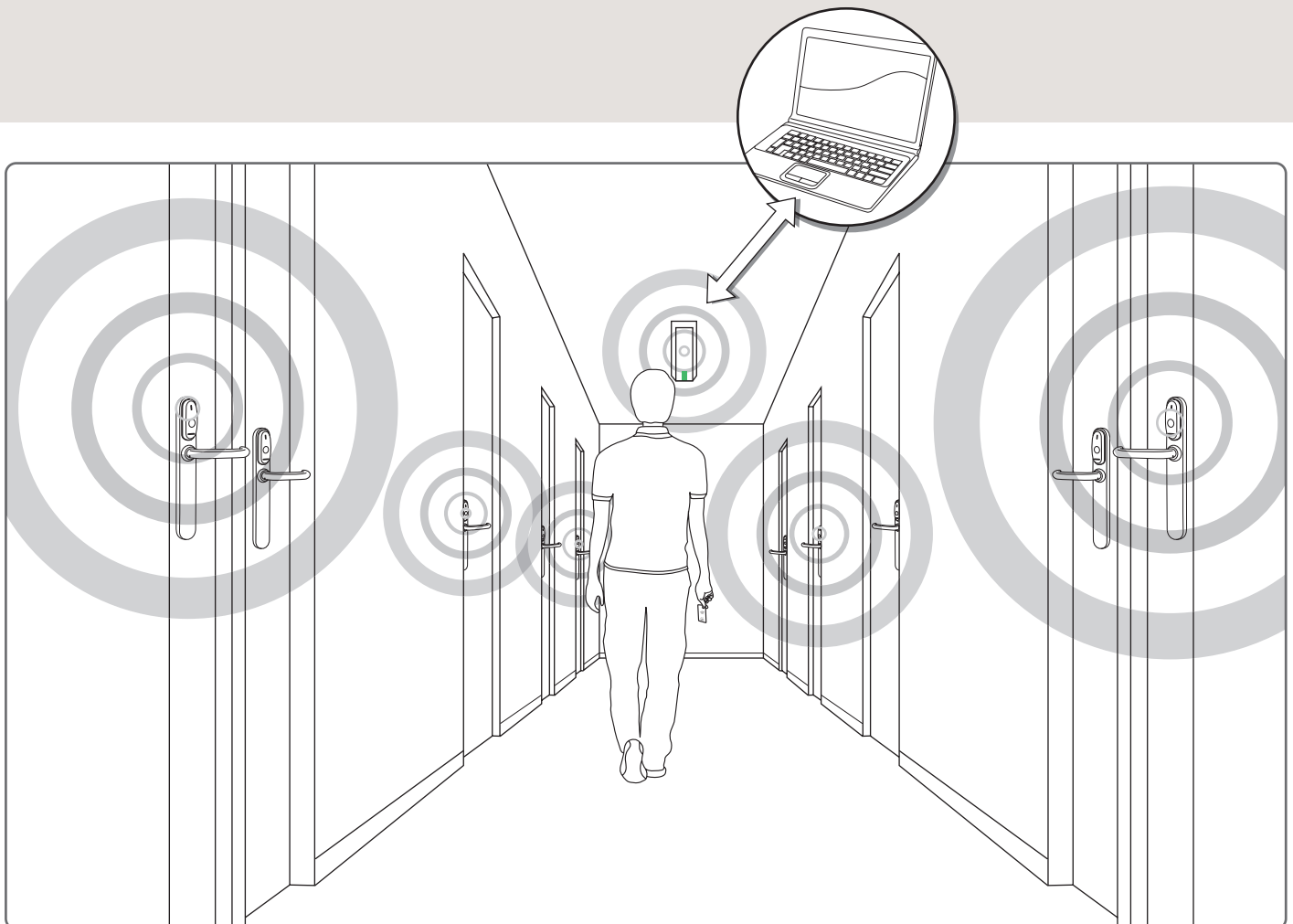

Main features and advantages

- **Easy installation** with a SALTO certified technician only needed to set up the XS4 RF parameters.
- **Each repeater/gateway** can control many XS4 on line locks, optimizing the cost/benefit relationship.
- **Key management** can be resolved in real time with a simple mouse click. XS4 RF sends the black list information to all the locks in real time.
- **Real time audit trail** means viewing door access in real time without having to visit the door.
- **Real time door control:** means viewing door status in real time.
- **Real time battery control** means maintenance can view power status live on screen.
- **Highly secure** meets RF IEEE 802.15.4 Standard and is 3DES encrypted.
- **Door data changes show** door opening mode, zone changes and calendars.
- **Supervision of the integrity** of the static network enables software to show the status of the gateways and repeaters.



Since its inception in 2001, SALTO Systems has grown to be the market leader in state-of-the-art electronic access control systems.

Recognizing the need for a new access control concept, SALTO has developed a wide range of innovative products such as the SALTO Virtual Network and XS4 access control platform.

Our distribution partner network now covers more than 60 countries to service international growth, and we have branch offices in Spain, UK, USA, Canada, Mexico, Portugal, Malaysia, Middle East, Australia and Netherlands with more planned in additional countries.



SALTO is able to offer all this and more. We are the selected access control option on over 600,000 doors, on more than 4,500 projects in over 60 countries. The power of the SALTO Virtual Network (SVN) allows people to work wire free enabling them to manage their key control requirements efficiently, flexibly and cost effectively.

Find out more about SALTO and our commitment to supply the access control market with a totally user friendly, stand alone system that provides any building with the flexibility it needs to function safely in an ever changing and demanding security environment.

Jump with us into the future and make your access control problems a thing of the past. SALTO is tomorrow's technology that's here today.

SALTO SYSTEMS HQ, Spain

Poligono Lanbaren
C/ Arkotz, 9
20180 Oiartzun, Spain
Tel.: +34 943 344 550
Fax: +34 943 341 621
email: info@saltosystems.com
www.saltosystems.com

SALTO SYSTEMS INC, Atlanta

3073 Mc Call Dr-1
Atlanta, GA30340
Tel.: (866) GO SALTO
Fax: (770) 452 6098
email: info@salto.us
www.salto.us

SALTO SYSTEMS LTD, Birmingham

Epic Innovation Centre
Barling Way, Nuneaton, CV10 7RH
United Kingdom
Tel.: +44 247 679 6430
Fax: +44 247 679 6431
email: info.uk@saltosystems.com
www.saltosystems.com

SALTO ASIA-PACIFIC, Kuala Lumpur

Suite 5.03, Plaza 138,
138 Jalan Ampang
50450, Kuala Lumpur, Malaysia
Tel.: +603 2382 3138
Fax: +603 2382 3139
email: info.asia@saltosystems.com
www.saltosystems.com

SALTO AUSTRALIA, Sydney

Level 39, Citigroup Centre
2 Park Street Sydney NSW,
2000 Australia
Tel.: +61 2 9004 7061
Fax: +61 2 9004 7070
email: info.sydney@saltosystems.com
www.saltosystems.com

SALTO AUSTRALIA, Melbourne

Level 50, 120 Collins Street
Melbourne, Victoria,
3000 Australia
Tel.: +61 3 9225 5401
Fax: +61 3 9225 5050
email: info.melbourne@saltosystems.com
www.saltosystems.com

SALTO CANADA, Montreal

15-101 Don Quichotte Blvd
Suite 526
J7V 7X4 Ile Perrot, QC
Tel.: (514) 616 2586
Fax: (514) 425 2187
email: info.canada@salto.us
www.salto.us

SALTO NETHERLANDS, Amsterdam

PO Box 36457
1020 ML Amsterdam
The Netherlands
Tel: +31(0) 650 562 021
Fax: +31(0) 203 375 716
email: info.nl@saltosystems.com
www.saltosystems.com

SALTO MÉXICO, Cancún

Toronja 4SM-2A
Cancún, Q. Roo 77500, México
Tel.: +52 998 887 8639
email: info.mexico@salto.us
www.salto.us

SALTO ME, Dubai

Jebel Ali, Dubai
Tel.: +971 50 667 95 94
email: info.me@saltosystems.com
www.saltosystems.com

SALTO PORTUGAL, Oporto

Largo Capitaio Pinheiro Torres de Meireles, 51/52, R/C
4150-619 Oporto, Portugal
Tel.: +351 220 937 508
+351 220 938 392
Fax: +351 220 935 871
Email: info.portugal@saltosystems.com
www.saltosystems.com